



DESIGN AND ANALYSIS OF TURBINE WING

¹Dr. M. Sivakumar, ²Dr. S. Ananth, ³Mrs.N. Sneha, ⁴Mr. R. Praveen Kumar,

¹Professor, Dept. of Mechanical Engineering, Malla Reddy College of Engineering, Sec-100

²Professor, Department of Mechanical Engineering, Malla Reddy College of Engineering, Sec-100

³Asst. Professor, Department of Mechanical Engineering, Malla Reddy College of Engineering, Sec-100

⁴Asst. Professor, Department of Mechanical Engineering, Malla Reddy College of Engineering,

ABSTRACT:

A Turbine blade is the individual component which makes up the turbine section of a gas turbine. The blades are responsible for extracting energy from the high temperature, high pressure gas produced by the combustor. The turbine blades are often the limiting component of gas turbines. To survive in this difficult environment, turbine blades often use exotic materials like super alloys and many different methods of cooling, such as internal air channels, boundary layer cooling, and thermal barrier coatings.

Key words:-Analysis,Modeling,Design

1.INTRODUCTION TO GAS TURBINE

A gas turbine, also called a combustion turbine, is a type of internal combustion engine. It has an upstream rotating compressor coupled to a downstream turbine, and a combustion chamber or area, called a combustor, in between.

The basic operation of the gas turbine is similar to that of the steam power plant except that air is used instead of water. Fresh atmospheric air flows through a compressor that brings it to higher pressure. Energy is then added by spraying fuel into the air and igniting it so the combustion generates a high-temperature flow. This high-temperature high-pressure gas enters a turbine, where it expands down to the exhaust pressure, producing a shaft work output in the process. The turbine shaft work is used to drive the compressor and other devices such as an electric generator that may be coupled to the shaft. The energy that is not used for shaft work comes out in the exhaust gases, so these have either a high temperature or a high velocity. The

purpose of the gas turbine determines the design so that the most desirable energy form is maximized. Gas turbines are used to power aircraft, trains, ships, electrical generators, and tanks.

1.1 Theory of operation

In an ideal gas turbine, gases undergo four thermodynamic processes: an isentropic compression, isobaric (constant pressure) combustion, an isentropic expansion and heat rejection. Together, these make up the Brayton cycle.

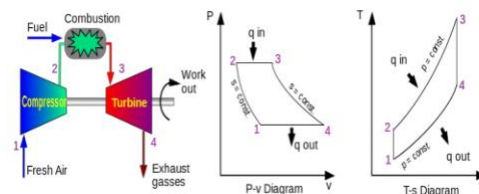

In a real gas turbine, mechanical energy is changed irreversibly (due to internal friction and turbulence) into pressure and thermal energy when the gas is compressed (in either a centrifugal or axial compressor). Heat is added in the combustion chamber and the specific volume of the gas increases, accompanied by a slight loss in pressure. During expansion through the stator and rotor passages in the turbine, irreversible energy transformation once again occurs.

Fresh air is taken in, in place of the heat rejection.

If the engine has a power turbine added to drive an industrial generator or a helicopter rotor, the exit pressure will be as close to the entry pressure as possible with only enough energy left to overcome the pressure losses in the

exhaust ducting and expel the exhaust. For a turboprop engine there will be a particular balance between propeller power and jet thrust which gives the most economical operation. In a jet engine only enough pressure and energy is extracted from the flow to drive the compressor and other components. The remaining high-pressure gases are accelerated to provide a jet to propel an aircraft.

The smaller the engine, the higher the rotation rate of the shaft(s) must be to attain the required blade tip speed. Blade-tip speed determines the maximum pressure ratios that can be obtained by the turbine and the compressor. This, in turn, limits the maximum power and efficiency that can be obtained by the engine. In order for tip speed to remain constant, if the diameter of a rotor is reduced by half, the rotational speed must double. For example, large jet engines operate around 10,000 rpm, while micro turbines spin as fast as 500,000 rpm.

Mechanically, gas turbines can be considerably less complex than internal combustion piston engines. Simple turbines might have one main moving part, the compressor/shaft/turbine rotor assembly (see image above), with other moving parts in the fuel system. However, the precision manufacture required for components and the temperature resistant alloys necessary for high efficiency often make the construction of a simple gas turbine more complicated than a piston engine.

More advanced gas turbines (such as those found in modern jet engines) may have 2 or 3 shafts (spools), hundreds of compressor and turbine blades, movable stator blades, and extensive external tubing for fuel, oil and air systems.

Thrust bearings and journal bearings are a critical part of design. They are hydrodynamic Oil bearings or oil cooled rolling-element bearings. Foil bearings are used in some small machines such as micro turbines and also have strong potential for use in small gas turbines/auxiliary power units.

2. 3D MODELS OF BLADES

2.1 Points

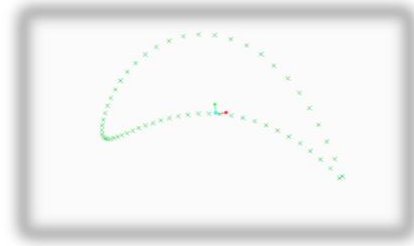

2.2 SKETCHER

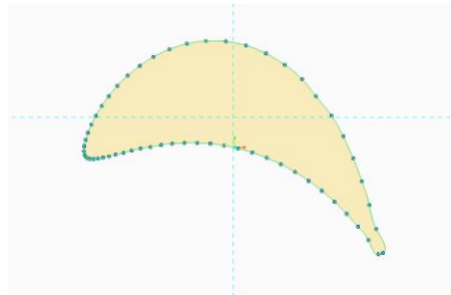

2.3 ORIGINAL MODEL WITHOUT HOLES

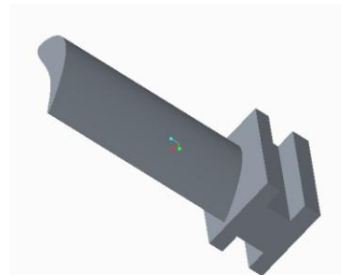

2.4 MODIFIED MODEL WITH 4 HOLES

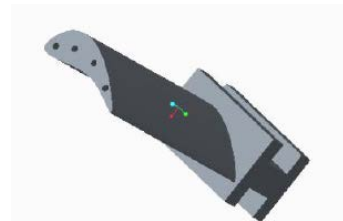

2.5 WITH 6 HOLES



2.6 WITH 8 HOLES



3. INTRODUCTION TO FEA

Finite element analysis is a method of solving, usually approximately, certain problems in engineering and science. It is used mainly for problems for which no exact solution, expressible in some mathematical form, is available. As such, it is a numerical rather than an analytical method. Methods of this type are needed because analytical methods cannot cope with the real, complicated problems that are met with in engineering. For example, engineering strength of materials or the mathematical theory of elasticity can be used to calculate analytically the stresses and strains in a bent beam, but neither will be very successful in finding out what is happening in part of a car suspension system during cornering.

One of the first applications of FEA was, indeed, to find the stresses and strains in engineering components under load. FEA, when applied to any realistic model of an engineering component, requires an enormous amount of computation and the development of the method has depended on the availability of suitable digital computers for it to run on. The method is now applied to problems involving a wide range of phenomena, including vibrations, heat conduction, fluid mechanics and electrostatics, and a wide range of material properties, such as linear-elastic (Hookean) behavior and behavior involving deviation from Hooke's law (for example, plasticity or rubber-elasticity).

Many comprehensive general-purpose computer packages are now available that can deal with a wide range of phenomena, together with more specialized packages for particular applications, for example, for the study of dynamic phenomena or large-scale plastic flow. Depending on the type and complexity of the analysis, such packages may run on a

microcomputer or, at the other extreme, on a supercomputer. FEA is essentially a piece-wise process. It can be applied to one-dimensional problems, but more usually there is an area or volume within which the solution is required. This is split up into a number of smaller areas or volumes, which are called finite elements. Figure 1 shows a two-dimensional model of a spanner that has been so divided: the process is called discretisation, and the assembly of elements is called a mesh.

4. INTRODUCTION TO ANSYS

Structural Analysis

ANSYS Autodyn is computer simulation tool for simulating the response of materials to short duration severe loadings from impact, high pressure or explosions.

4.1 ANSYS Mechanical

ANSYS Mechanical is a finite element analysis tool for structural analysis, including linear, nonlinear and dynamic studies. This computer simulation product provides finite elements to model behavior, and supports material models and equation solvers for a wide range of mechanical design problems. ANSYS Mechanical also includes thermal analysis and coupled-physics capabilities involving acoustics, piezoelectric, thermal-structural and thermo-electric analysis.

4.2 Fluid Dynamics

ANSYS Fluent, CFD, CFX, FENSAP-ICE and related software are Computational Fluid Dynamics software tools used by engineers for design and analysis. These tools can simulate fluid flows in a virtual environment — for example, the fluid dynamics of ship hulls; gas turbine engines (including the compressors, combustion chamber, turbines and afterburners); aircraft aerodynamics; pumps, fans, HVAC systems, mixing vessels, hydro cyclones, vacuum cleaners, etc.

5. STRUCTURAL ANALYSIS OF GAS TURBINE BLADE WITHOUT HOLES TITANIUM ALLOY

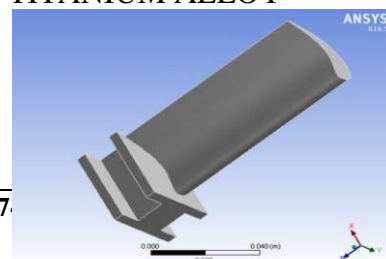

5.1 Material properties of Titanium Alloy

Density : 0.0000134 kg/mm³
 Young's modulus : 125000Mpa
 Poisson's ratio : 0.342

Meshed model

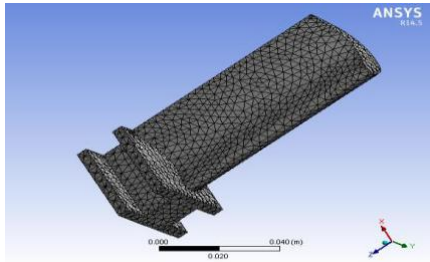

Meshed model

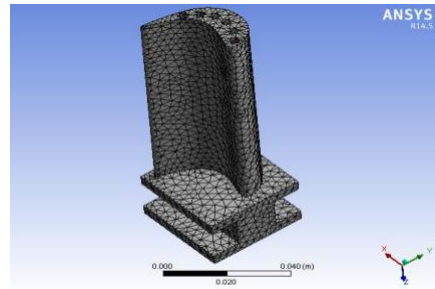

5.2 WITH 4 HOLES

TITANIUM ALLOY

Pressure

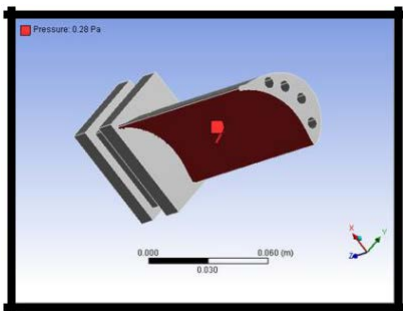

Displacement

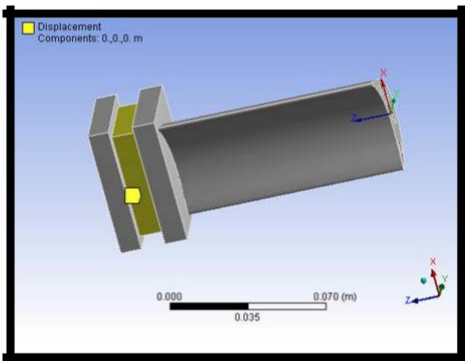

5.3 TITANIUM ALLOY

Save CREO Model as .iges format

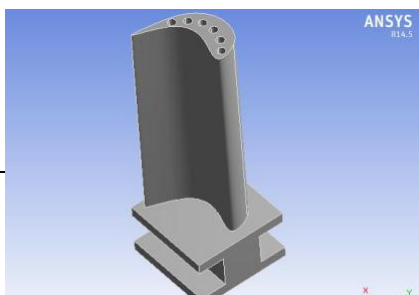

5.4 THERMAL ANALYSIS ON GAS TURBINE BLADE

TITANIUM ALLOY
 WITHOUT HOLES

Import model

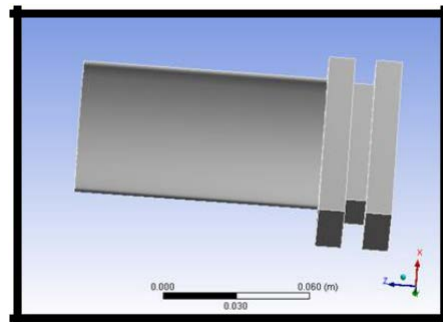

Material Properties of Titanium Alloy

Density : 0.00000484 kg/mm³
 Thermal conductivity : 10.9 w/mk
 Specific heat: 670 j/g⁰c

Meshed model

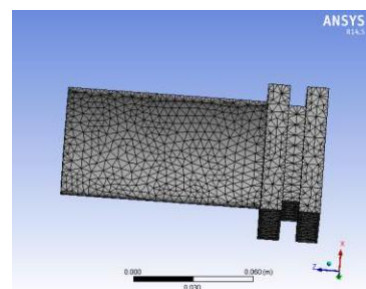

6. CONCLUSION

In our project we have designed a turbine blade used in gas turbines and modeled in 3D modeling software Pro/Engineer. Two other models with 4 holes and 6 holes are also modeled.

We have done structural and thermal analysis on all the models of turbine blades using Titanium alloy and Nickel alloy. By observing the analysis results, the analyzed stress values are less than their permissible stress values. So using both the materials is safe. The stress and deformation values are more for Nickel alloy.

By observing the thermal results, thermal flux is more for Nickel alloy than titanium alloy. So using Nickel alloy is better than Titanium alloy. But the main disadvantage is its weight.

By comparing the results for all the models, thermal flux is increasing by increasing number of holes, so heat transfer rate is increased.

So we can conclude that by using Nickel alloy with 6 holes is better.

7. REFERENCES

- 1.Design and Analysis of Gas Turbine Blade by Theju V, Uday P S , PLV Gopinath Reddy, C.J.Manjunath
- 2.Heat Transfer Analysis of Gas Turbine Blade Through Cooling Holes by K Hari Brahmaiah , M.Lava Kumar
- 3.The design and analysis of gas turbine blade by Pedaprolu Venkata Vinod
- 4.Effect Of Temperature Distribution In 10c4/60c50 Gas Turbine Blade Model Using Finite Element Analysis by V.Veeraragavan
- 5.Film Cooling on a Gas Turbine Rotor Blade by K. Takeishi, S. Aoki, T. Sato and K. Tsukagoshi
- 6.Film Cooling of the Gas Turbine Endwall by Discrete-Hole Injection by M. Y. Jabbari, K. C. Marston, E. R.G. Eckert and R. J. Goldstein

7.An advanced impingement/film cooling scheme for gas turbines – numerical study by A. Immarigeon, (Department of Mechanical and Industrial Engineering, Concordia University, Montréal, Canada), I. Hassan, (Department of Mechanical and Industrial Engineering, Concordia University, Montréal, Canada)

8.An experimental investigation on the trailing edge cooling of turbine blades by Zifeng Yang, Hui Hu

9.CFD Simulation on Gas turbine blade and Effect of Hole Shape on leadingedgeFilmCooling Effectiveness by Shridhar Paregouda, Prof. Dr. T. Nageswara Rao